

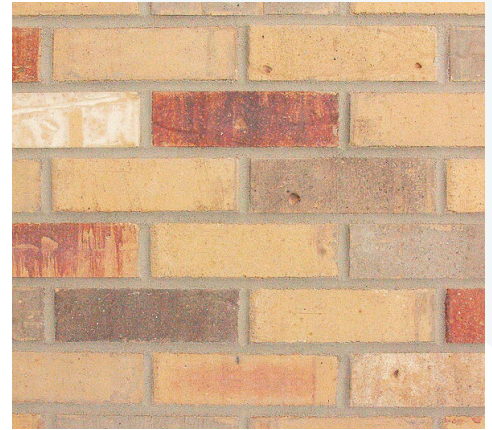

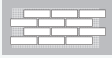

Pony Express

COLONIAL COLLECTION

Reminiscent of the fields of the midwest with wheat tones accented by pops of clay and amber.

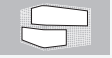

| FORMATS |  |  |  |  |  |
|------------|---|---|---|---|---|
| SKU # | Brickwebb Sheets BW-37009CS | Brickwebb Herringbone BWH-37009CS | Thin Brick Singles TB-27009CS | Brickwebb Corners BWC-37009CS | Thin Brick Corners TBC-27009CS |
| DIMENSIONS | 28" x 10-1/2" x 1/2" | 28" x 12-1/2" x 1/2" | 7-5/8" x 2-1/4" x 1/2" | 21" x 7-5/8" x 7-5/8" x 1/2" | 7-5/8" x 3-5/8" x 2-1/4" x 1/2" |
| QUANTITY | 5 sheets/60 bricks box | 5 sheets/60 bricks box | 50 bricks/box | 3 sheets/24 bricks box | 25 bricks corners/box |

FEATURES

- Quick and easy do-it-yourself installation
- Patented web sheeting allows for easy installation, perfect spacing, and enhanced durability – ensuring your bricks will stay in place longer than the competition
- Pre-fastened brick veneer for quick and easy installation
- Traditional masonry that can be installed where full brick can't
- Cuts easily with an angle grinder or wet tile saw
- Adds comfort, style, and value to your home or business

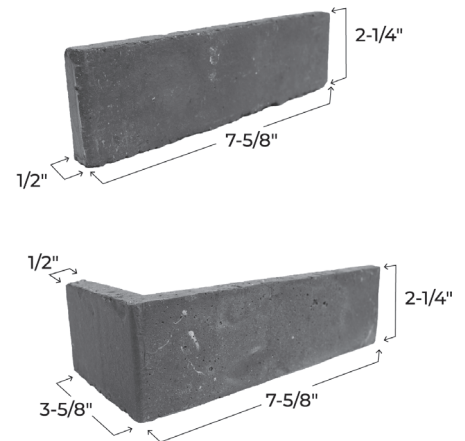

| | |
|----------------------------|--|
| AVAILABLE SIZES | 2 1/4" Modular |
| AVAILABLE TEXTURES | Straight Edge |
| ASTM C 1088 SPECIFICATIONS | Type: TBS (Standard), Grade Exterior |
| CLEANING RECOMMENDATIONS | See BIA Technical Note 20 "Cleaning Brick" |

Colors illustrated above are fairly represented, but may be depicted differently through photography limitations.

oldmill
THIN BRICK SYSTEMS™

oldmillbrick.com

©2020 Old Mill Brick, LLC